

An Overview of Compilation and GCC

GCC Resource Center
(www.cse.iitb.ac.in/grc)

Department of Computer Science and Engineering,
Indian Institute of Technology, Bombay



30 June 2012

Outline

- Introduction to Compilation
- An Overview of Compilation Phases
- An Overview of GCC

Part 1

Introduction to Compilation



Binding

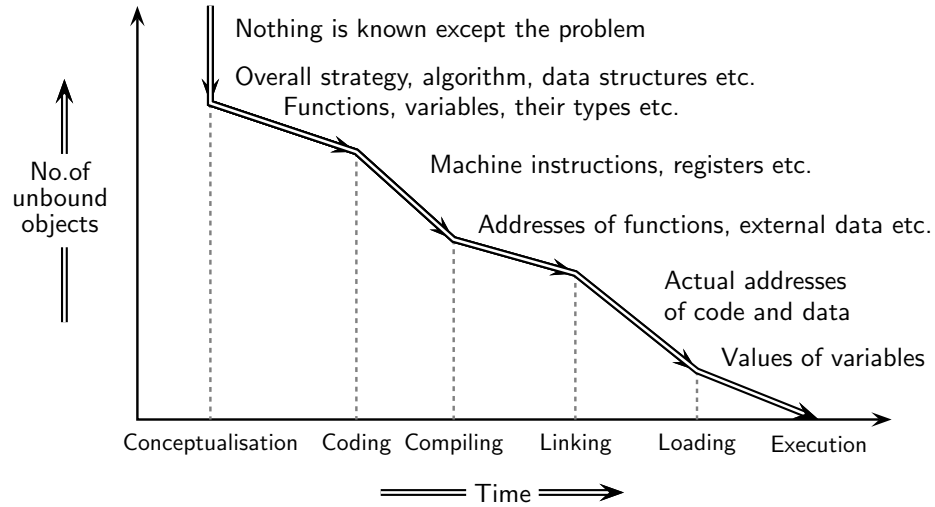

Binding

Notes



Binding

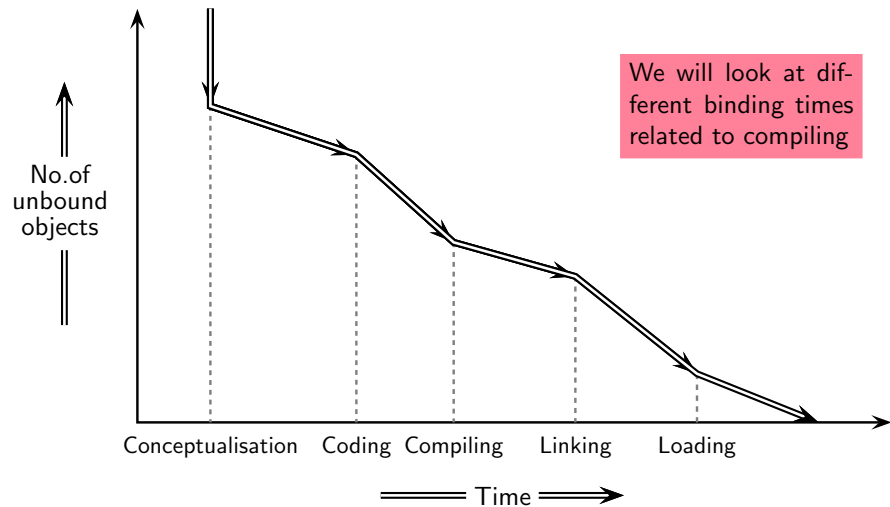

Binding

Notes



Implementation Mechanisms

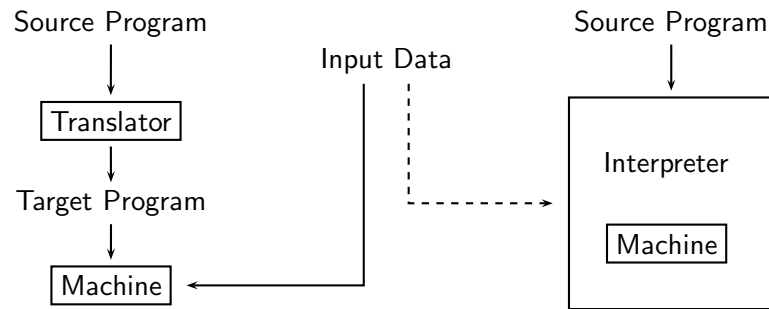

Implementation Mechanisms

Notes



Implementation Mechanisms as “Bridges”

- “Gap” between the “levels” of program specification and execution

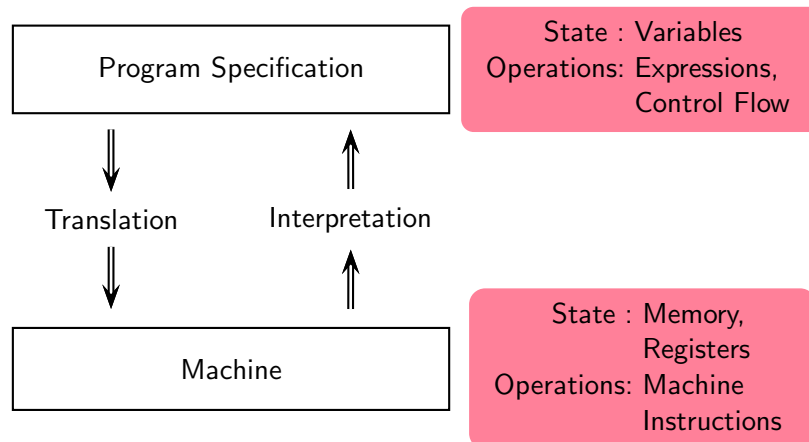

Implementation Mechanisms as “Bridges”

Notes



High and Low Level Abstractions

Input C statement

```
a = b<10?b:c;
```

Spim Assembly Equivalent

```

lw  $t0, 4($fp) ;   t0 <- b      # Is b smaller
slti $t0, $t0, 10 ; t0 <- t0 < 10 # than 10?
not  $t0, $t0      ;   t0 <- !t0
bgtz $t0, L0:      ;   if t0>0 goto L0
lw  $t0, 4($fp) ;   t0 <- b      # YES
b   L1:            ;   goto L1
L0: lw  $t0, 8($fp) ;L0: t0 <- c  # NO
L1: sw  0($fp), $t0 ;L1: a <- t0

```



High and Low Level Abstractions

Notes



High and Low Level Abstractions

Input C statement

```
a = b<10?b:c;
```

Spim Assembly Equivalent

```

lw  $t0, 4($fp) ;   t0 <- b      # Is b smaller
slti $t0, $t0, 10 ; t0 <- t0 < 10 # than 10?
not  $t0, $t0      ;   t0 <- !t0
bgtz $t0, L0:      ;   if t0>0 goto L0
lw  $t0, 4($fp) ;   t0 <- b      # YES
b   L1:            ;   goto L1
L0: lw  $t0, 8($fp) ;L0: t0 <- c  # NO
L1: sw  0($fp), $t0 ;L1: a <- t0

```

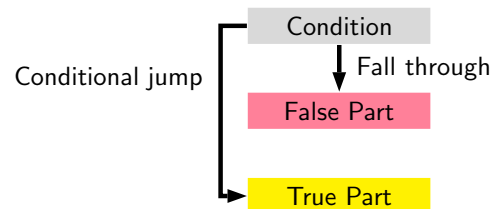

High and Low Level Abstractions

Notes



High and Low Level Abstractions

Input C statement

```
a = b < 10 ? b : c;
```

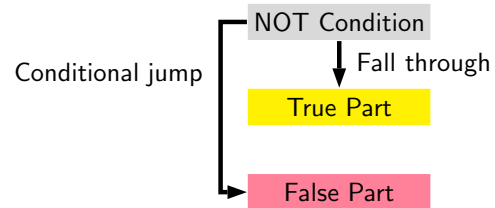

Spim Assembly Equivalent

```

lw  $t0, 4($fp) ; t0 <- b      # Is b smaller
slti $t0, $t0, 10 ; t0 <- t0 < 10 # than 10?
not  $t0, $t0 ; t0 <- !t0
bgtz $t0, L0: ; if t0 > 0 goto L0
lw  $t0, 4($fp) ; t0 <- b      # YES
b   L1: ; goto L1
L0: lw  $t0, 8($fp) ; L0: t0 <- c # NO
L1: sw  0($fp), $t0 ; L1: a <- t0
  
```



High and Low Level Abstractions

Notes



Implementation Mechanisms

- Translation = Analysis + Synthesis
- Interpretation = Analysis + Execution

- Translation Instructions \Rightarrow Equivalent Instructions

Interpretation Instructions \Rightarrow Actions Implied by Instructions



Implementation Mechanisms

Notes



Language Implementation Models

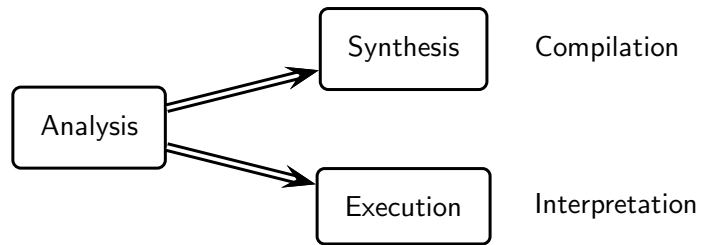

Language Processor Models

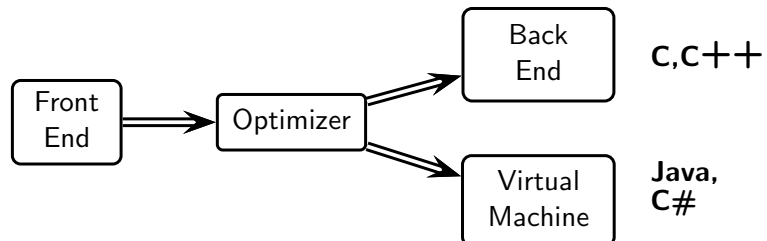

Language Implementation Models

Notes



Language Processor Models

Notes



An Overview of Compilation Phases

The Structure of a Simple Compiler

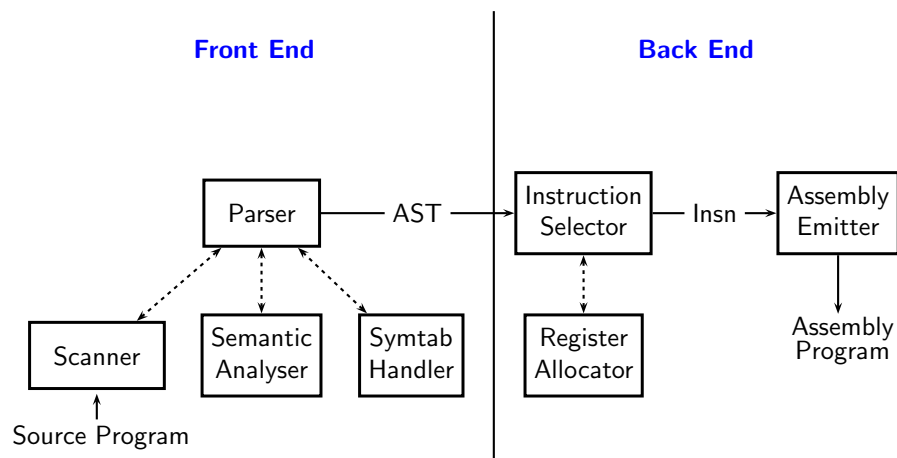

The Structure of a Simple Compiler

Notes



Translation Sequence in Our Compiler: Parsing

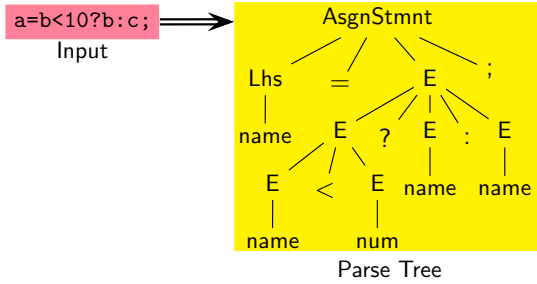

Issues:

- Grammar rules, terminals, non-terminals
- Order of application of grammar rules
eg. is it `(a = b<10?)` followed by `(b:c)`?
- Values of terminal symbols
eg. string "10" vs. integer number 10.



Translation Sequence in Our Compiler: Parsing

Notes



Translation Sequence in Our Compiler: Semantic Analysis

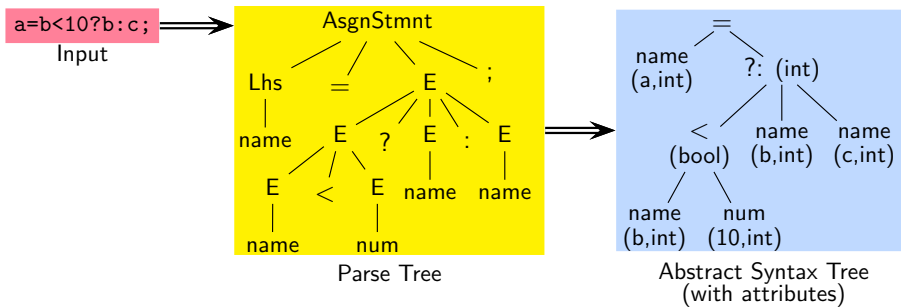

Issues:

- Symbol tables
Have variables been declared? What are their types?
What is their scope?
- Type consistency of operators and operands
The result of computing `b<10?` is `bool` and not `int`



Translation Sequence in Our Compiler: Semantic Analysis

Notes



Translation Sequence in Our Compiler: IR Generation

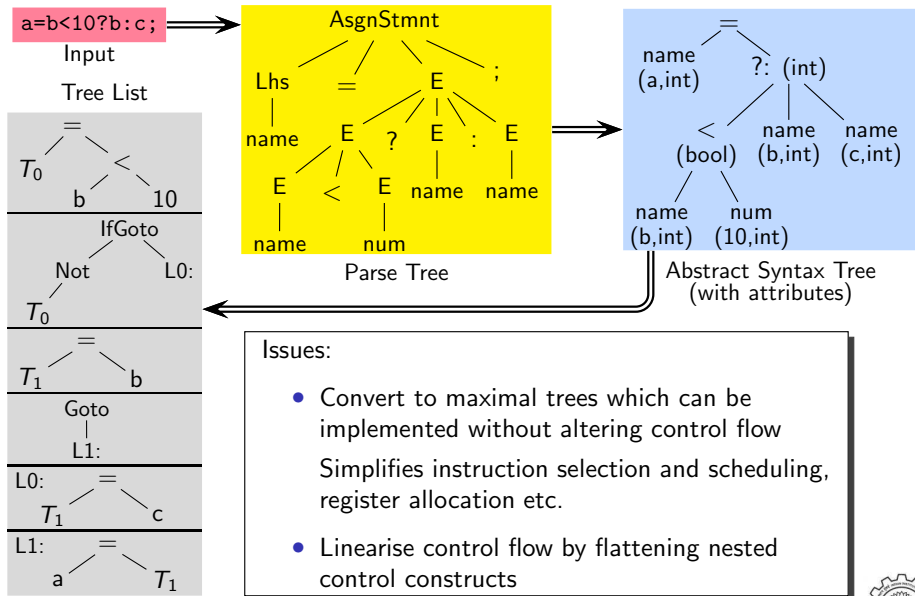

Translation Sequence in Our Compiler: IR Generation

Notes



Translation Sequence in Our Compiler: Instruction Selection

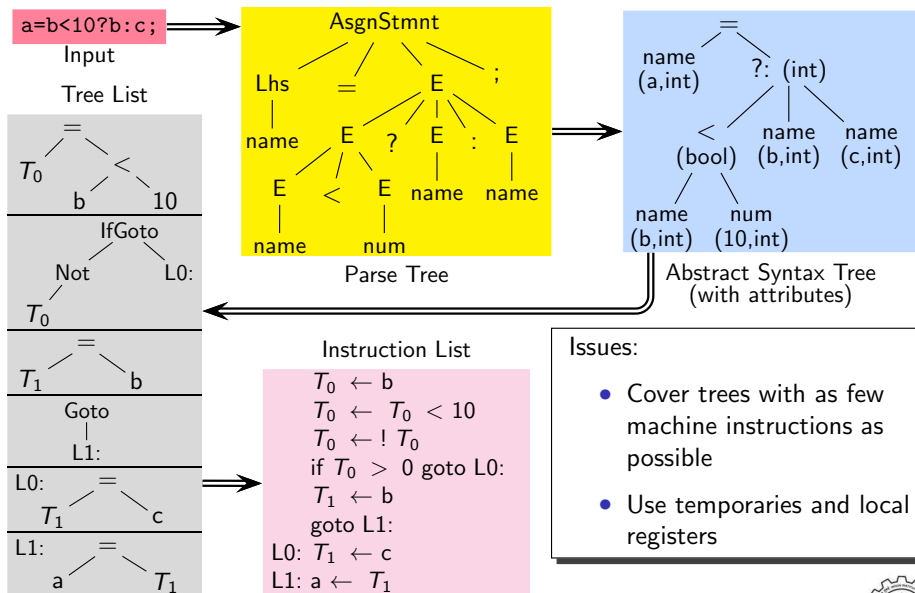

Translation Sequence in Our Compiler: Instruction Selection

Notes



Translation Sequence in Our Compiler: Emitting Instructions

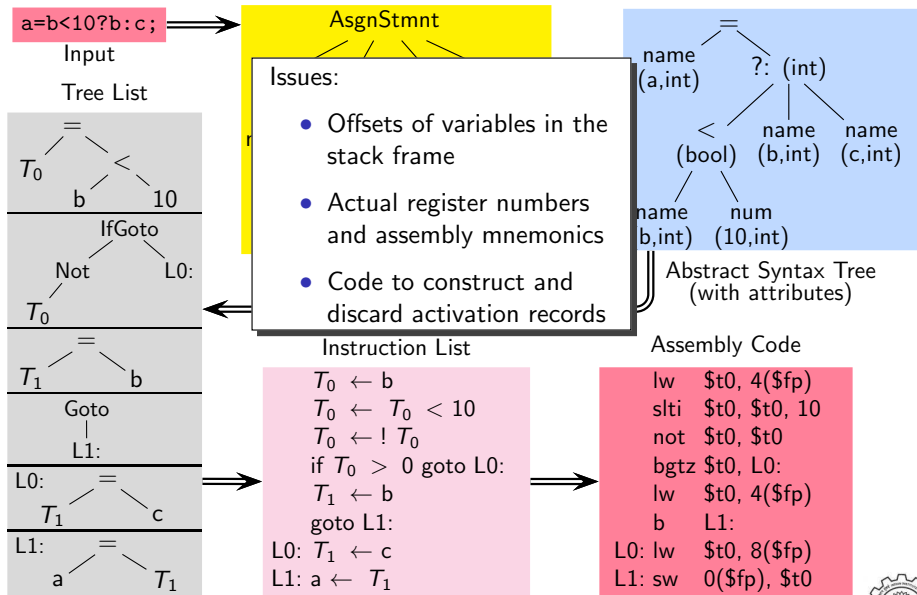

Translation Sequence in Our Compiler: Emitting Instructions

Notes



Part 3

Compilation Models

Compilation Models

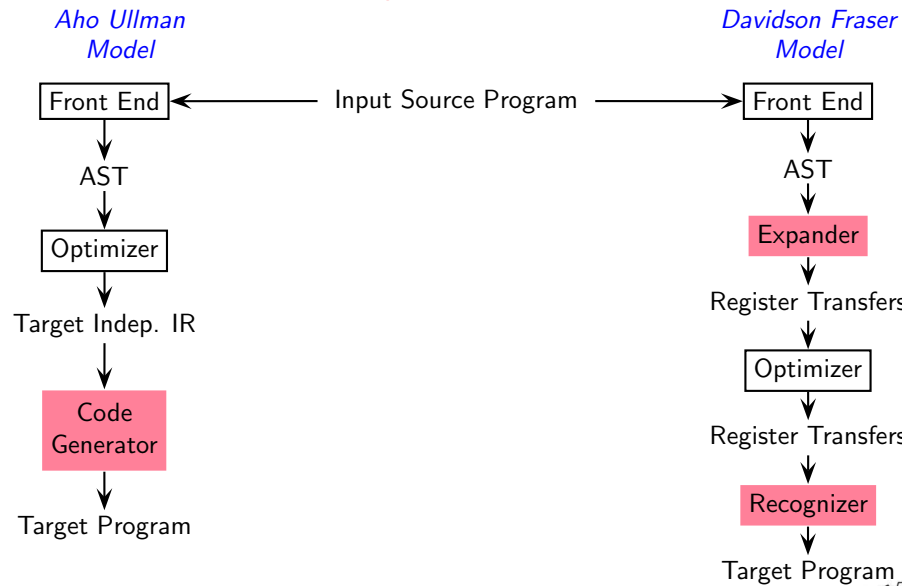

Compilation Models

Notes



Compilation Models

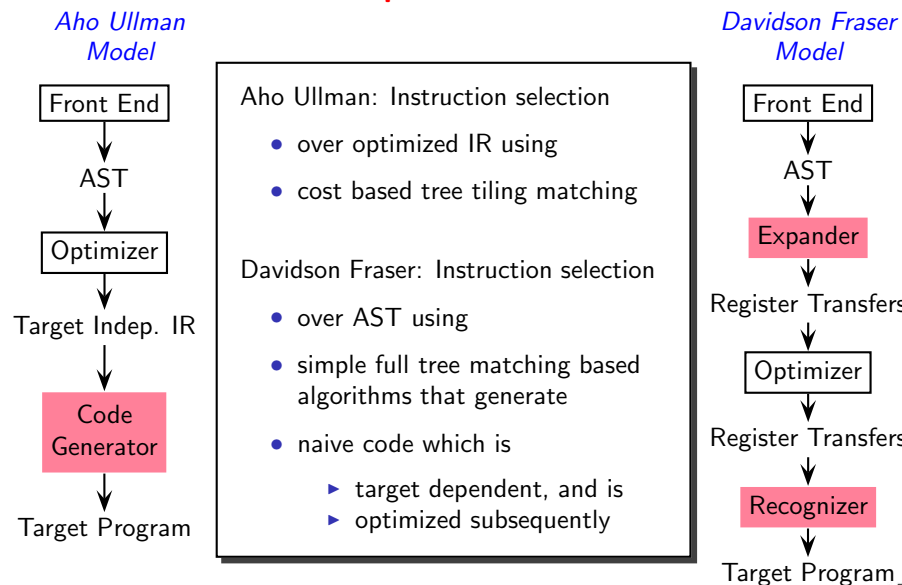

Compilation Models

Notes



Typical Front Ends

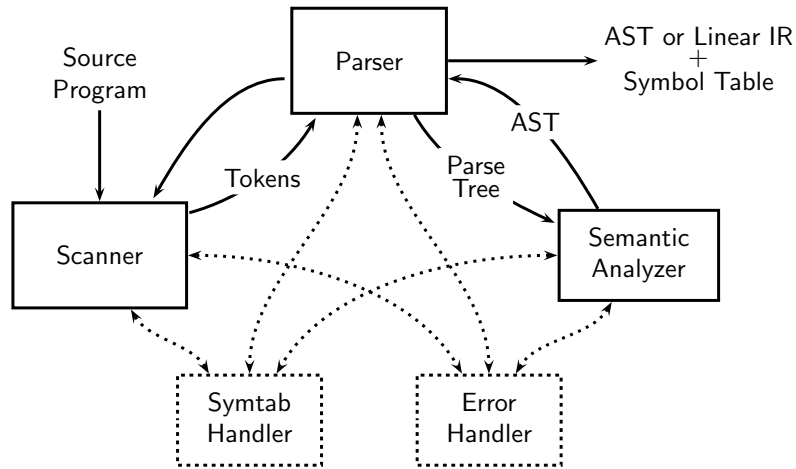

Typical Front Ends

Notes



Typical Back Ends in Aho Ullman Model

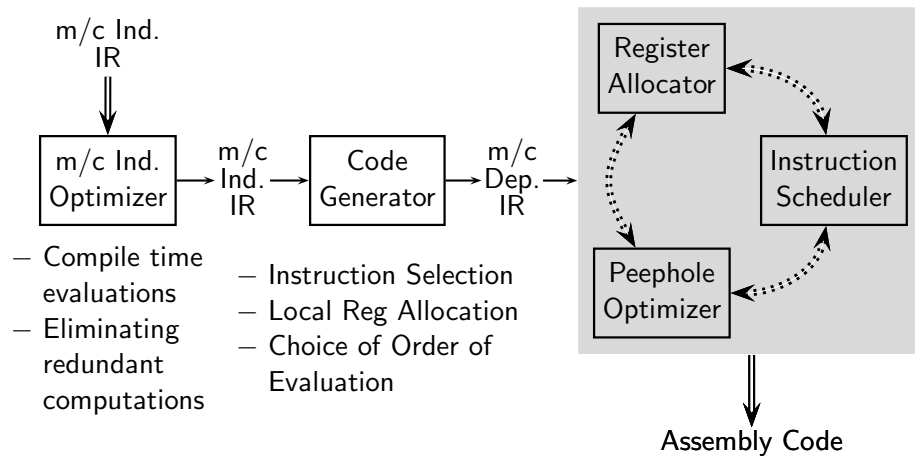

Typical Back Ends in Aho Ullman Model

Notes



Retargetability in Aho Ullman and Davidson Fraser Models

	Aho Ullman Model	Davidson Fraser Model
Instruction Selection	<ul style="list-style-type: none"> Machine independent IR is expressed in the form of trees Machine instructions are described in the form of trees Trees in the IR are "covered" using the instruction trees 	
	Cost based tree pattern matching	Structural tree pattern matching
Optimization	Machine independent	Machine dependent
		Key Insight: <i>Register transfers are target specific but their form is target independent</i>



Retargetability in Aho Ullman and Davidson Fraser Models

Notes



Part 4

GCC ≡ The Great Compiler Challenge

What is GCC?

- For the GCC developer community: [The GNU Compiler Collection](#)
- For other compiler writers: [The Great Compiler Challenge](#) 😊



The GNU Tool Chain for C

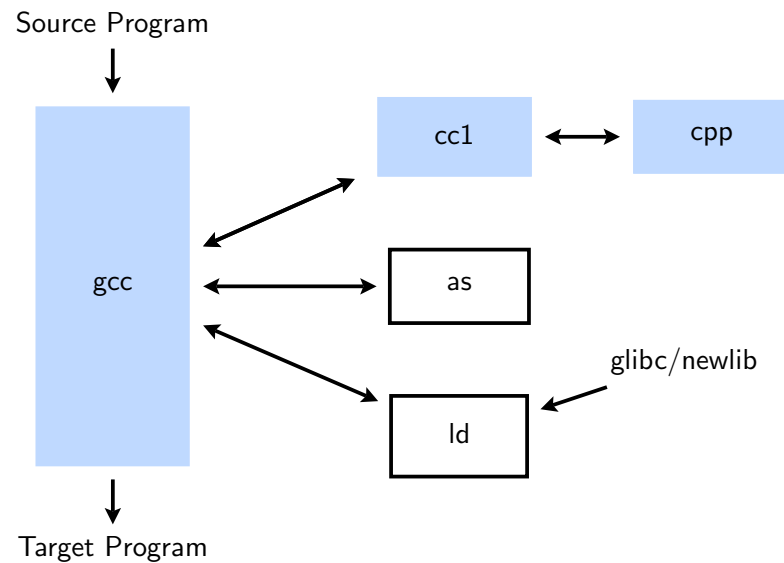

What is GCC?

Notes



The GNU Tool Chain for C

Notes



Why is Understanding GCC Difficult?

Some of the obvious reasons:

- **Comprehensiveness**

GCC is a production quality framework in terms of completeness and practical usefulness

- **Open development model**

Could lead to heterogeneity. Design flaws may be difficult to correct

- **Rapid versioning**

GCC maintenance is a race against time. Disruptive corrections are difficult



Open Source and Free Software Development Model

The Cathedral and the Bazaar [Eric S Raymond, 1997]

- **Cathedral: Total Centralized Control**

Design, implement, test, release

- **Bazaar: Total Decentralization**

Release early, release often, make users partners in software development

“Given enough eyeballs, all bugs are shallow”

Code errors, logical errors, and architectural errors

A combination of the two seems more sensible



Why is Understanding GCC Difficult?

Notes



Open Source and Free Software Development Model

Notes



The Current Development Model of GCC

GCC follows a combination of the Cathedral and the Bazaar approaches

- GCC Steering Committee: Free Software Foundation has given charge
 - ▶ Major policy decisions
 - ▶ Handling Administrative and Political issues
- Release Managers:
 - ▶ Coordination of releases
- Maintainers:
 - ▶ Usually area/branch/module specific
 - ▶ Responsible for design and implementation
 - ▶ Take help of reviewers to evaluate submitted changes



Comprehensiveness of GCC: Wide Applicability

- **Input languages supported:**
C, C++, Objective-C, Objective-C++, Java, Fortran, and Ada
- **Processors supported in standard releases:**
 - ▶ **Common processors:**
Alpha, ARM, Atmel AVR, Blackfin, HC12, H8/300, IA-32 (x86), x86-64, IA-64, Motorola 68000, MIPS, PA-RISC, PDP-11, PowerPC, R8C/M16C/M32C, SPU, System/390/zSeries, SuperH, SPARC, VAX
 - ▶ **Lesser-known target processors:**
A29K, ARC, ETRAX CRIS, D30V, DSP16xx, FR-30, FR-V, Intel i960, IP2000, M32R, 68HC11, MCORE, MMIX, MN10200, MN10300, Motorola 88000, NS32K, ROMP, Stormy16, V850, Xtensa, AVR32
 - ▶ **Additional processors independently supported:**
D10V, LatticeMico32, MeP, Motorola 6809, MicroBlaze, MSP430, Nios II and Nios, PDP-10, TIGCC (m68k variant), Z8000, PIC24/dsPIC, NEC SX architecture



The Current Development Model of GCC

Notes



Comprehensiveness of GCC: Wide Applicability

Notes



Comprehensiveness of GCC: Size

• Overall size

	Subdirectories	Files
gcc-4.4.2	3794	62301
gcc-4.5.0	4056	65639
gcc-4.6.0	4383	71096

• Core size (src/gcc)

	Subdirectories	Files
gcc-4.4.2	257	30163
gcc-4.5.0	283	32723
gcc-4.6.0	336	36503

• Machine Descriptions (src/gcc/config)

	Subdirectories	.c files	.h files	.md files
gcc-4.4.2	36	241	426	206
gcc-4.5.0	42	275	478	206
gcc-4.6.0	42	275	466	259



Comprehensiveness of GCC: Size

Notes



ohcount: Line Count of gcc-4.4.2

Language	Files	Code	Comment	Comment %	Blank	Total
c	15638	1840245	394682	17.7%	366815	2601742
cpp	19622	872775	190744	17.9%	189007	1252526
java	6342	681656	643045	48.5%	169465	1494166
ada	4206	638557	294881	31.6%	218000	1151438
autoconf	76	445046	393	0.1%	58831	504270
make	82	110064	3268	2.9%	13270	126602
html	480	103080	5658	5.2%	21438	130176
fortranfixed	2164	73366	1570	2.1%	9454	84390
assembler	183	42460	9607	18.5%	7084	59151
shell	137	39347	8832	18.3%	5485	53664
fortranfree	690	11852	2582	17.9%	1414	15848
objective_c	395	10562	1768	14.3%	2951	15281
automake	61	6014	853	12.4%	956	7823
perl	24	4111	1138	21.7%	732	5981
scheme	1	2775	153	5.2%	328	3256
ocaml	5	2482	538	17.8%	328	3348
python	6	1135	211	15.7%	220	1566
awk	9	1127	324	22.3%	193	1644
pascal	4	1044	141	11.9%	218	1403
csharp	9	879	506	36.5%	230	1615
dcl	2	497	99	16.6%	30	626
tcl	1	392	113	22.4%	72	577
haskell	48	149	0	0.0%	16	165
emacsisp	1	59	21	26.2%	4	84
matlab	2	57	0	0.0%	7	64
Total	50312	4938881	1567750	24.1%	1071986	7578617



ohcount: Line Count of gcc-4.4.2

Notes



ohcount: Line Count of gcc-4.5.0

Language	Files	Code	Comment	Comment %	Blank	Total
c	16985	1967826	413941	17.4%	391883	2773650
cpp	20813	912618	210084	18.7%	199605	1322307
java	6342	681810	643127	48.5%	169483	1494420
ada	4412	647372	302226	31.8%	222481	1172079
autoconf	79	358996	422	0.1%	55631	415049
html	487	144535	5667	3.8%	31773	181975
make	93	114490	3438	2.9%	14434	132362
fortranfixed	2535	85905	1817	2.1%	11394	99116
assembler	197	45098	10082	18.3%	7528	62708
shell	136	39789	8984	18.4%	5511	54284
scheme	7	13725	1192	8.0%	1524	16441
fortranfree	760	12955	2889	18.2%	1546	17390
objective_c	396	10782	1835	14.5%	2959	15576
automake	64	6388	914	12.5%	994	8296
perl	25	4144	1139	21.6%	739	6022
xslt	20	2805	436	13.5%	563	3804
ocaml	5	2515	540	17.7%	328	3383
python	10	1686	322	16.0%	383	2391
awk	10	1352	372	21.6%	218	1942
pascal	4	1044	141	11.9%	218	1403
csharp	9	879	506	36.5%	230	1615
dcl	2	402	84	17.3%	13	499
tcl	1	392	113	22.4%	72	577
haskell	49	153	0	0.0%	17	170
emacsclisp	1	59	21	26.2%	4	84
matlab	1	5	0	0.0%	0	5



ohcount: Line Count of gcc-4.5.0

Notes



ohcount: Line Count of gcc-4.6.0

Language	Files	Code	Comment	Comment %	Blank	Total
c	18463	2100237	444333	17.5%	418292	2962862
cpp	22002	985076	229541	18.9%	214781	1429398
java	6342	681938	645505	48.6%	169046	1496489
ada	4605	680043	315956	31.7%	234467	1230466
autoconf	91	405461	509	0.1%	62914	468884
html	457	168355	5669	3.3%	38146	212170
make	98	121545	3659	2.9%	15618	140822
fortranfixed	2936	99413	1927	1.9%	13659	114999
shell	148	48032	10451	17.9%	6586	65069
assembler	208	46727	10227	18.0%	7853	64807
xml	75	36036	282	0.8%	3827	40145
objective_c	866	28014	5000	15.1%	8115	41129
fortranfree	821	13857	3147	18.5%	1695	18699
tex	2	11060	5776	34.3%	1433	18269
scheme	6	11023	1010	8.4%	1205	13238
automake	67	9440	1038	9.9%	1456	11934
perl	28	4445	1316	22.8%	837	6598
ocaml	6	2814	576	17.0%	378	3768
xslt	20	2805	436	13.5%	563	3804
awk	11	1740	396	18.5%	257	2393
python	10	1725	322	15.7%	383	2430
css	24	1589	143	8.3%	332	2064
pascal	4	1044	141	11.9%	218	1403
csharp	9	879	506	36.5%	230	1615
dcl	2	402	84	17.3%	13	499
tcl	1	392	113	22.4%	72	577
javascript	4	341	87	20.3%	35	463
haskell	49	153	0	0.0%	17	170
bat	3	7	0	0.0%	0	7
matlab	1	5	0	0.0%	0	5
Total	57359	5464598	1688150	23.6%	1202428	8355176



ohcount: Line Count of gcc-4.6.0

Notes



ohcount: Line Count of gcc-4.6.2

Language	Files	Code	Comment	Comment %	Blank	Total
c	18624	2106311	445288	17.5%	419325	2970924
cpp	22206	989098	230376	18.9%	215739	1435213
java	6342	681938	645505	48.6%	169046	1496489
ada	4616	680251	316021	31.7%	234551	1230823
autoconf	91	405517	509	0.1%	62919	468945
html	457	168378	5669	3.3%	38146	212193
make	98	121136	3658	2.9%	15555	140349
fortranfixed	2989	100688	1950	1.9%	13894	116532
shell	148	48032	10451	17.9%	6586	65069
assembler	208	46750	10227	17.9%	7854	64831
xml	75	36178	282	0.8%	3827	40287
objective_c	869	28049	5023	15.2%	8124	41196
fortranfree	831	13996	3204	18.6%	1728	18928
tex	2	11060	5776	34.3%	1433	18269
scheme	6	11023	1010	8.4%	1205	13238
automake	67	9442	1039	9.9%	1457	11938
perl	28	4445	1316	22.8%	837	6598
ocaml	6	2814	576	17.0%	378	3768
xslt	20	2805	436	13.5%	563	3804
awk	11	1740	396	18.5%	257	2393
python	10	1725	322	15.7%	383	2430
css	24	1589	143	8.3%	332	2064
pascal	4	1044	141	11.9%	218	1403
csharp	9	879	506	36.5%	230	1615
dcl	2	402	84	17.3%	13	499
tcl	1	392	113	22.4%	72	577
javascript	4	341	87	20.3%	35	463
haskell	49	153	0	0.0%	17	170
bat	3	7	0	0.0%	0	7
matlab	1	5	0	0.0%	0	5
Total	57801	5476188	1690108	23.6%	1204724	8371020



ohcount: Line Count of gcc-4.4.2/gcc

Language	Files	Code	Comment	Comment %	Blank	Total
c	13296	1254253	282582	18.4%	283766	1820601
ada	4196	636876	294321	31.6%	217401	1148598
cpp	7418	184186	52163	22.1%	54048	290397
fortranfixed	2086	67988	1521	2.2%	9079	78588
assembler	132	31092	7243	18.9%	4770	43105
autoconf	3	26996	10	0.0%	3383	30389
fortranfree	652	10898	2376	17.9%	1314	14588
objective_c	391	10155	1654	14.0%	2830	14639
make	3	5340	1027	16.1%	814	7181
scheme	1	2775	153	5.2%	328	3256
ocaml	5	2482	538	17.8%	328	3348
shell	16	2256	712	24.0%	374	3342
awk	7	1022	251	19.7%	187	1460
perl	1	772	205	21.0%	137	1114
haskell	48	149	0	0.0%	16	165
matlab	2	57	0	0.0%	7	64
Total	28258	2242738	647591	22.4%	579484	3469813



ohcount: Line Count of gcc-4.6.2

Notes



ohcount: Line Count of gcc-4.4.2/gcc

Notes



ohcount: Line Count of gcc-4.5.0/gcc

Language	Files	Code	Comment	Comment %	Blank	Total
c	14565	1368937	300284	18.0%	305671	1974892
ada	4402	645691	301666	31.8%	221882	1169239
cpp	7984	197798	54719	21.7%	57312	309829
fortranfixed	2453	80403	1768	2.2%	11008	93179
assembler	136	31802	7431	18.9%	4864	44097
autoconf	3	27317	10	0.0%	3876	31203
scheme	7	13725	1192	8.0%	1524	16441
fortranfree	722	12001	2683	18.3%	1446	16130
objective_c	392	10375	1721	14.2%	2838	14934
make	3	5886	1039	15.0%	854	7779
ocaml	5	2515	540	17.7%	328	3383
shell	14	2101	642	23.4%	347	3090
awk	8	1247	299	19.3%	212	1758
perl	2	805	206	20.4%	144	1155
haskell	49	153	0	0.0%	17	170
matlab	1	5	0	0.0%	0	5
Total	30747	2406202	677035	22.0%	613025	3696262



ohcount: Line Count of gcc-4.6.0/gcc

Language	Files	Code	Comment	Comment %	Blank	Total
c	15787	1462494	321820	18.0%	324179	2108493
ada	4595	678362	315396	31.7%	233868	1227626
cpp	8666	252213	61026	19.5%	67144	380383
fortranfixed	2850	93549	1878	2.0%	13260	108687
assembler	137	31548	7446	19.1%	4857	43851
autoconf	3	28775	12	0.0%	4020	32807
objective_c	861	27465	4822	14.9%	7967	40254
fortranfree	783	12903	2936	18.5%	1595	17434
scheme	6	11023	1010	8.4%	1205	13238
make	4	6078	1070	15.0%	893	8041
tex	1	5441	2835	34.3%	702	8978
ocaml	6	2814	576	17.0%	378	3768
shell	16	1980	597	23.2%	338	2915
awk	9	1635	323	16.5%	251	2209
perl	3	866	225	20.6%	158	1249
haskell	49	153	0	0.0%	17	170
matlab	1	5	0	0.0%	0	5
Total	33777	2617304	721972	21.6%	660832	4000108



ohcount: Line Count of gcc-4.5.0/gcc

Notes



ohcount: Line Count of gcc-4.6.0/gcc

Notes



ohcount: Line Count of gcc-4.6.2/gcc

Language	Files	Code	Comment	Comment %	Blank	Total
c	15943	1468358	322727	18.0%	325166	2116251
ada	4606	678570	315461	31.7%	233952	1227983
cpp	8845	255337	61446	19.4%	67828	384611
fortranfixed	2900	94766	1901	2.0%	13490	110157
assembler	137	31551	7446	19.1%	4856	43853
autoconf	3	28791	12	0.0%	4020	32823
objective_c	864	27500	4845	15.0%	7976	40321
fortranfree	793	13042	2993	18.7%	1628	17663
scheme	6	11023	1010	8.4%	1205	13238
make	4	6087	1070	15.0%	893	8050
tex	1	5441	2835	34.3%	702	8978
ocaml	6	2814	576	17.0%	378	3768
shell	16	1980	597	23.2%	338	2915
awk	9	1635	323	16.5%	251	2209
perl	3	866	225	20.6%	158	1249
haskell	49	153	0	0.0%	17	170
matlab	1	5	0	0.0%	0	5
Total	34186	2627919	723467	21.6%	662858	4014244



Why is Understanding GCC Difficult?

Deeper technical reasons

- GCC is not a compiler but a *compiler generation framework*
 - Two distinct gaps that need to be bridged
 - ▶ Input-output of the generation framework
 - The target specification and the generated compiler
 - ▶ Input-output of the generated compiler
 - A source program and the generated assembly program
- GCC generated compiler uses a derivative of the Davidson-Fraser model of compilation
 - ▶ Early instruction selection
 - ▶ Machine dependent intermediate representation
 - ▶ Simplistic instruction selection and retargetability mechanism



ohcount: Line Count of gcc-4.6.2/gcc

Notes



Why is Understanding GCC Difficult?

Notes



The Architecture of GCC

Compiler Generation Framework

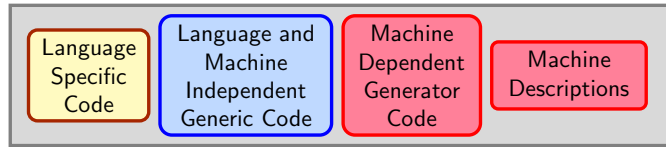

Source Program

Generated Compiler (cc1)

Assembly Program



The Architecture of GCC

Notes



The Architecture of GCC

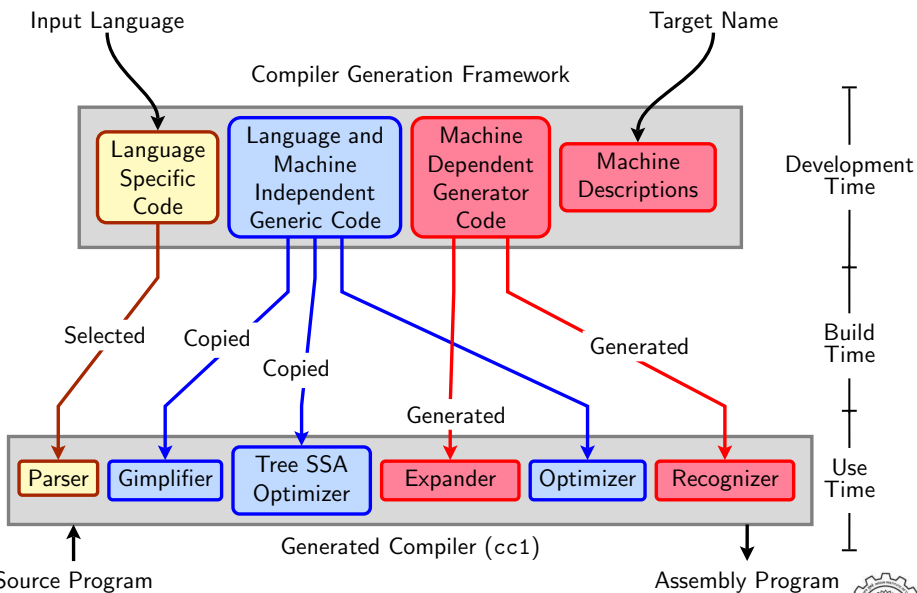

The Architecture of GCC

Notes



An Example of The Generation Related Gap

- Predicate function for invoking the loop distribution pass

```
static bool
gate_tree_loop_distribution (void)
{
    return flag_tree_loop_distribution != 0;
}
```

- There is no declaration of or assignment to variable `flag_tree_loop_distribution` in the entire source!
- It is described in `common.opt` as follows

```
floop-distribution
Common Report Var(flag_tree_loop_distribution) Optimization
Enable loop distribution on trees
```

- The required C statements are generated during the build



Another Example of The Generation Related Gap

- Locating the main function in `gcc-4.6.2/gcc` using `cscope -R`

7359 occurrences!

- Number of main functions in the entire tarball

11777!

- What if we do not search recursively?



An Example of The Generation Related Gap

Notes



Another Example of The Generation Related Gap

Notes



Another Example of The Generation Related Gap

Locating the main function in the directory gcc-4.6.2/gcc using cscope

File	Line	
0 collect2.c	1076	main (int argc, char **argv)
1 fp-test.c	85	main (void)
2 gcc.c	6092	main (int argc, char **argv)
3 gcov-dump.c	76	main (int argc ATTRIBUTE_UNUSED, char **argv)
4 gcov-iov.c	29	main (int argc, char **argv)
5 gcov.c	360	main (int argc, char **argv)
6 genattr.c	164	main (int argc, char **argv)
7 genattrtab.c	4820	main (int argc, char **argv)
8 genautomata.c	9459	main (int argc, char **argv)
9 genchecksum.c	97	main (int argc, char ** argv)
a gencodes.c	51	main (int argc, char **argv)
b genconditions.c	209	main (int argc, char **argv)
c genconfig.c	261	main (int argc, char **argv)
d genconstants.c	79	main (int argc, char **argv)
e genemit.c	830	main (int argc, char **argv)
f genenums.c	48	main (int argc, char **argv)



Another Example of The Generation Related Gap

Locating the main function in the directory gcc-4.6.2/gcc using cscope

g genextract.c	402	main (int argc, char **argv)
h genflags.c	251	main (int argc, char **argv)
i gengenrtl.c	282	main (void)
j gengtype.c	4825	main (int argc, char **argv)
k genhooks.c	335	main (int argc, char **argv)
l genmddeps.c	43	main (int argc, char **argv)
m genmodes.c	1376	main (int argc, char **argv)
n genopinit.c	473	main (int argc, char **argv)
o genoutput.c	999	main (int argc, char **argv)
p genpeep.c	353	main (int argc, char **argv)
q genpreds.c	1388	main (int argc, char **argv)
r genrecog.c	2691	main (int argc, char **argv)
s lto-wrapper.c	628	main (int argc, char *argv[])
t main.c	34	main (int argc, char **argv)
u mips-tdump.c	1393	main (int argc, char **argv)
v mips-tfile.c	655	main (void)
w mips-tfile.c	4693	main (int argc, char **argv)
x tlink.c	64	const char *main;



Another Example of The Generation Related Gap

Notes



Another Example of The Generation Related Gap

Notes



GCC Retargetability Mechanism

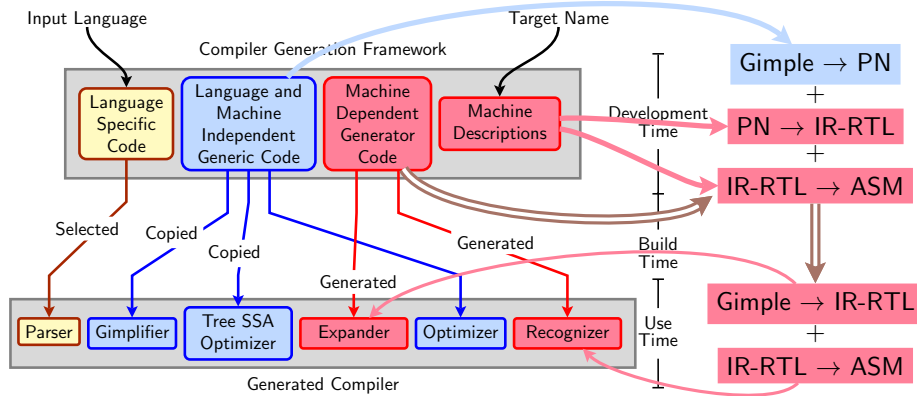

The generated compiler uses an adaptation of the Davison Fraser model

- Generic expander and recognizer
- Machine specific information is isolated in data structures
- Generating a compiler involves generating these data structures



GCC Retargetability Mechanism

Notes



The GCC Challenge: Poor Retargetability Mechanism

Symptoms:

- Machine descriptions are large, verbose, repetitive, and contain large chunks of C code

Size in terms of line counts in gcc-4.6.2 (counted using `wc -l`)

Files	i386	mips	arm
*.md	38851	15534	30951
*.c	39780	16793	26165
*.h	17879	5667	18713
Total	96510	37996	75929

- Machine descriptions are difficult to construct, understand, debug, and enhance



The GCC Challenge: Poor Retargetability Mechanism

Notes



Meeting the GCC Challenge

Goal of Understanding	Methodology	Needs Examining		
		Makefiles	Source	MD
Translation sequence of programs	Gray box probing	No	No	No
Build process	Customizing the configuration and building	Yes	No	No
Retargetability issues and machine descriptions	Incremental construction of machine descriptions	No	No	Yes
IR data structures and access mechanisms	Adding passes to massage IRs	No	Yes	Yes
Retargetability mechanism		Yes	Yes	Yes



Workshop Coverage

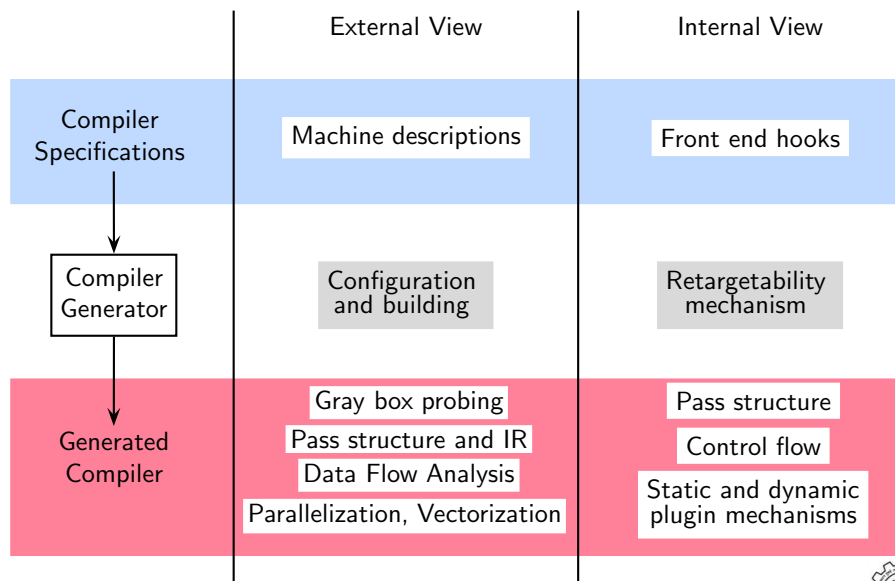

Meeting the GCC Challenge

Notes



Workshop Coverage

Notes

